

# MOBA MATIC & BIG SONIC SKI



20

20

MOBA MATIC & BIG SONIC SKI /  
LEVELLING SYSTEMS  
[MOBA-AUTOMATION.COM](http://MOBA-AUTOMATION.COM)

# MOBA MATIC - THE WORLD'S MOST FLEXIBLE LEVELLING SYSTEM FOR ROAD CONSTRUCTION

The world-renowned **MOBA-matic** is the best-selling levelling system in road construction. Its simple operation, exceptional robustness and absolute precision have ensured its strong market positioning. The technology, which was introduced in 1991, is now the leading levelling system in road construction and is installed as standard on asphalt pavers of all major machine manufacturers.

After a single set-up, the system immediately controls the screed thickness – fully automated. Combined with the appropriate CAN-based sensors, even the most complex construction project can be accomplished. In more than 45 years on the market, the MOBA control unit and sensors have been perfectly matched to each other to form a single unit. The right solution has been developed specifically for every application in asphalt paving. Benefit now from the world's largest selection of sensors!



As a combination, **MOBA-matic** and the sensor solution **Big Sonic-Ski** with up to 4 ultrasonic sensors are absolutely unbeatable! Thanks to a span of up to 13 m, even long ground waves are completely levelled out and eliminated. This unique feature ensures an exceptionally flat surface and makes the system not only the most precise technology on the market, but also an absolutely groundbreaking solution. Welcome to road construction of the future!



## 45 YEARS OF PIONEERING SPIRIT

We live progress! More than **45 years of experience** in road construction and pioneering spirit since the first day distinguish MOBA Mobile Automation AG as an innovator in the automation industry. **MOBA-matic** and **Big Sonic-Ski** are firmly established in the market as leading systems and are indispensable today.

### Did you know?

Our proven technologies for road construction are always supplemented by newly developed innovation systems to ensure long-term quality in road construction. With systems such as **PAVE-IR** for automatic temperature measurement and **PAVE-TM** for non-contact coating thickness measurement, your machines will be perfectly equipped for the construction site of the future.



# MOBA-MATIC II

## VERSATILITY ERGONOMICALLY PACKED

### SYSTEM ADVANTAGES

- » Increased efficiency through fully automatic control of the screed thickness
- » High-precision levelling results
- » Universal operation possible on all types of pavers
- » Flexible applications thanks to largest CAN-based sensor selection
- » Ergonomic, intuitive 4-button design
- » Time-saving through 3D capability
- » Cost-effective upgrades possible thanks to exceptional modularity



## MOBA-MATIC II CONTROLLER

### THE „HEART” OF THE SYSTEM

The controller of the **MOBA-matic** is characterised by its exceptionally ergonomic handling. The practical 4-button design for quick and easy operation has been integrated into every further development and has been further optimised. Specially developed features such as the easy-to-read design for night operation and the practical illuminated display as a height indicator complement the intuitive operation of the panel. The particularly robust technology convinces first and foremost in terms of durability. Some of them have already been in use **for more than 20 years**.

# MOBA-MATIC II DISPLAY

## EVERYTHING AT A GLANCE

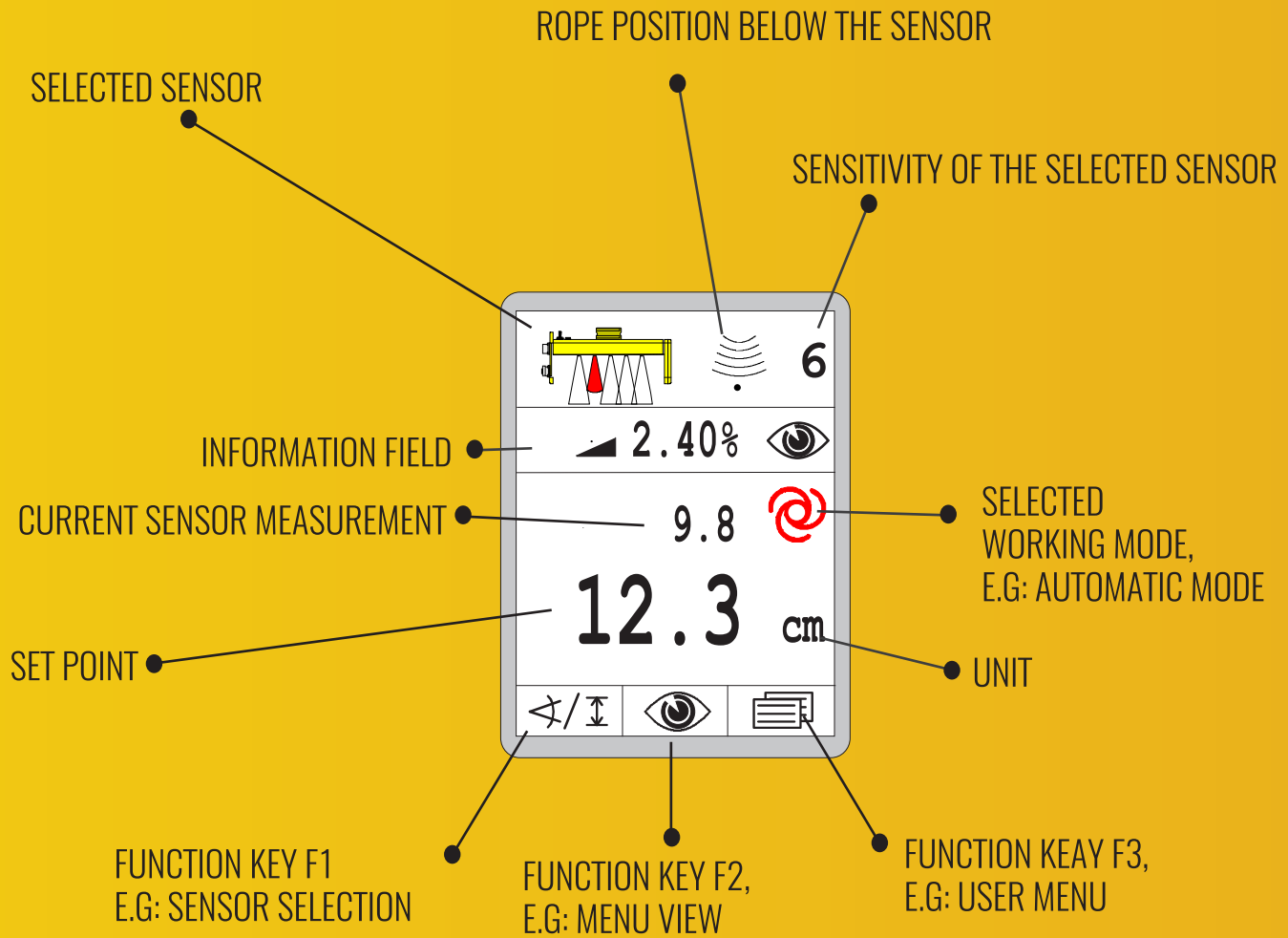



# BIG SONIC-SKI

NOBODY IS THIS **SMOOTH**

### SONIC-SKI PLUS

- » Wear-free sensor
- » Non-contact rope and ground sensing
- » Determination of measured values taking into consideration interference factors



01

### DIGI SLOPE

- » Specially designed for high compaction screeds
- » Inclination display for height control



02

### LASER RECEIVER LS-3000

- » Compatible with all common rotary lasers for machine control
- » Linear detection of the laser beam
- » No electric mast required for height adjustment
- » Operating point selection at the touch of a button



03

### ROTARY ENCODER

- » Can be used in all weather conditions
- » Suitable for rope and ground sensing



04

### JUNCTION BOX

- » connects 3 Sonic-Ski grade sensors with CAN interfaces
- » Interfaces: CAN ISO 11898 – 24 V – 125 kBit/sec
- » Ingress protection: IP67



05

### IR TEMPERATURESENSOR

- » Measurement of material temperature
- » Installation in the material hopper or in front of the paver
- » Real-time temperature display on the MOBA-matic II



06



Sensor 1 + Sensor 2 + Sensor 3 + Sensor 4 + Sensor 5

3

The **Sonic-Ski PLUS** has been in constant development for 20 years and has firmly established itself as a flexible sensor technology in road construction. Thus, the sensor can be changed from ground to rope sensing in just one action and is therefore a real time miracle with changing references. As an ultrasonic sensor that scans the height reference without contact, it is completely wear-free and therefore far superior to other technologies in terms of durability. Disturbing influences such as rain, stones or edges are immediately detected and faded out to guarantee the installation of an absolutely even surface.

- » Wear-free sensor thanks to non-contact sensing
- » Absolute robustness of measured value owing to suppression of interference factors
- » Absolute robustness of measured value owing to suppression of interference factors
- » Flexible, time-efficient adaptation to different references





# DIGI SLOPE FAVOURING SLOPES

The digital inclination sensor can be optimally integrated into the CAN network of the system and thus complements the levelling system with a powerful inclination control for paving slopes. The state-of-the-art technology systematically suppresses shocks and accelerations and thus makes your levelling work many times more precise. Thanks to the minimal cable installation, the number of wear parts and the associated potential sources of error are reduced to a minimum.

## ADVANTAGES:

- » Faster operation thanks to automated tilt control
- » New generation digital sensor that works even faster and more precisely
- » Cable savings thanks to integration into the CAN bus

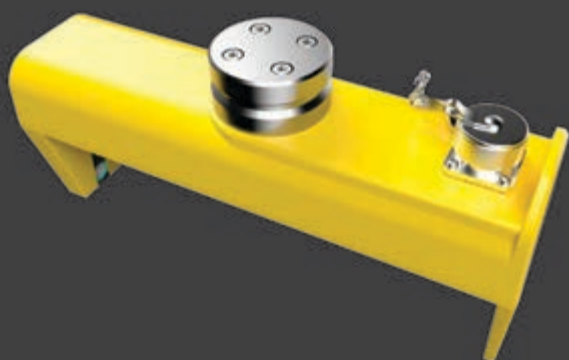

# SONIC SKI PLUS FLATNESS PERFECTED



# BIG SONIC-SKI - QUICKLY ASSEMBLED – THE BEST RESULTS

With up to four variably positionable sensors, the Big Sonic-Ski is a sensor solution in a class of its own. The combination of four sensors is the only technology on the market that detects long-wave unevenness and thus achieves the most precise flatness.

Thanks to quick mounting on the robust aluminium frame, the sensors can be placed individually for each application to measure the height at the right place. Thus, the Big Sonic-Ski is the right solution for every project – whether road, car park, racetrack, airport or roundabout, whether straight road or winding track. Adjustments in the installation are implemented on site in the shortest possible time.

Thanks to non-contact ground sensing of the acoustic ultrasonic sensors, this technology is considered wear-free. The system's longevity is particularly impressive in harsh environments. Its resistance to heat, vibration, dust and water is an absolute must on the construction site.

## SYSTEM ADVANTAGES

- » High precision through constant averaging of measurements from four independent sensors
- » Time-saving owing to user-friendly assembly and flexible handling
- » Increased uniformity by sensing large surfaces



# BIG SONIC-SKI - AVERAGING OVER LONG DISTANCES

- » Combination of 4 Sonic-Ski Plus sensors
- » Sensing of several, widely spaced points
- » Averaging and derivation of a virtual reference level
- » Even elongated irregularities are levelled out

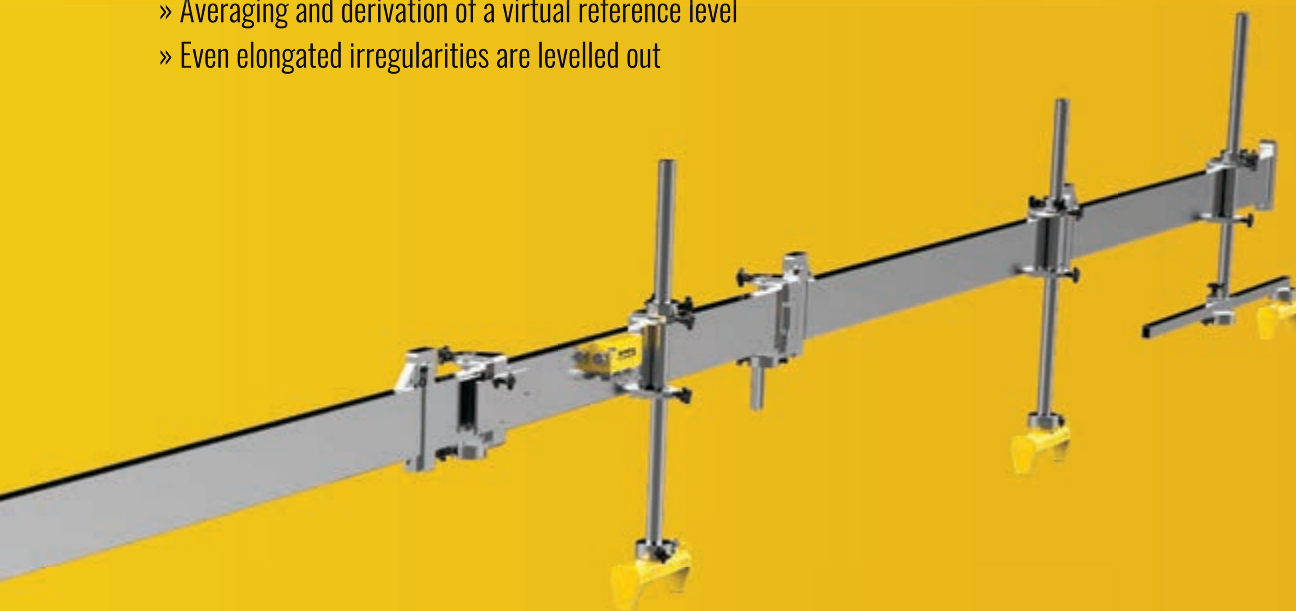

**SKI1+SKI2+SKI3+SKI4**

4

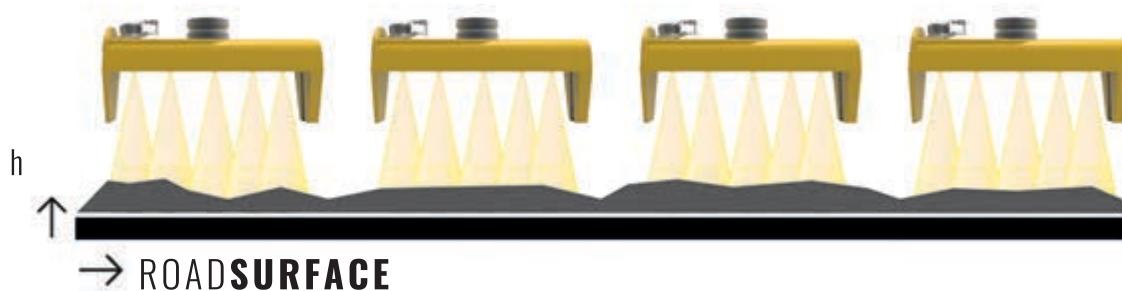

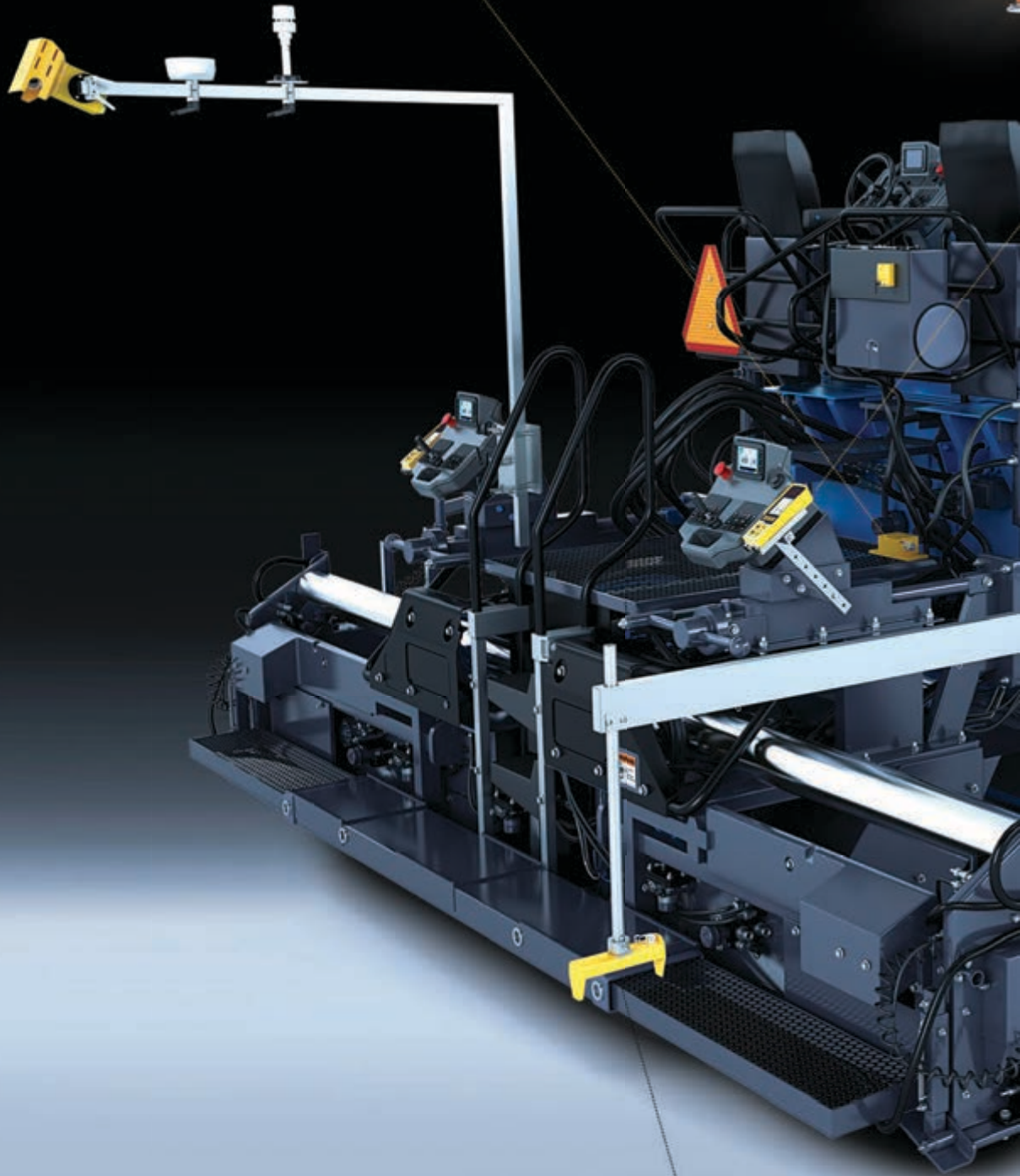

## ABSOLUTE FLATNESS WITH EVERY PAVER





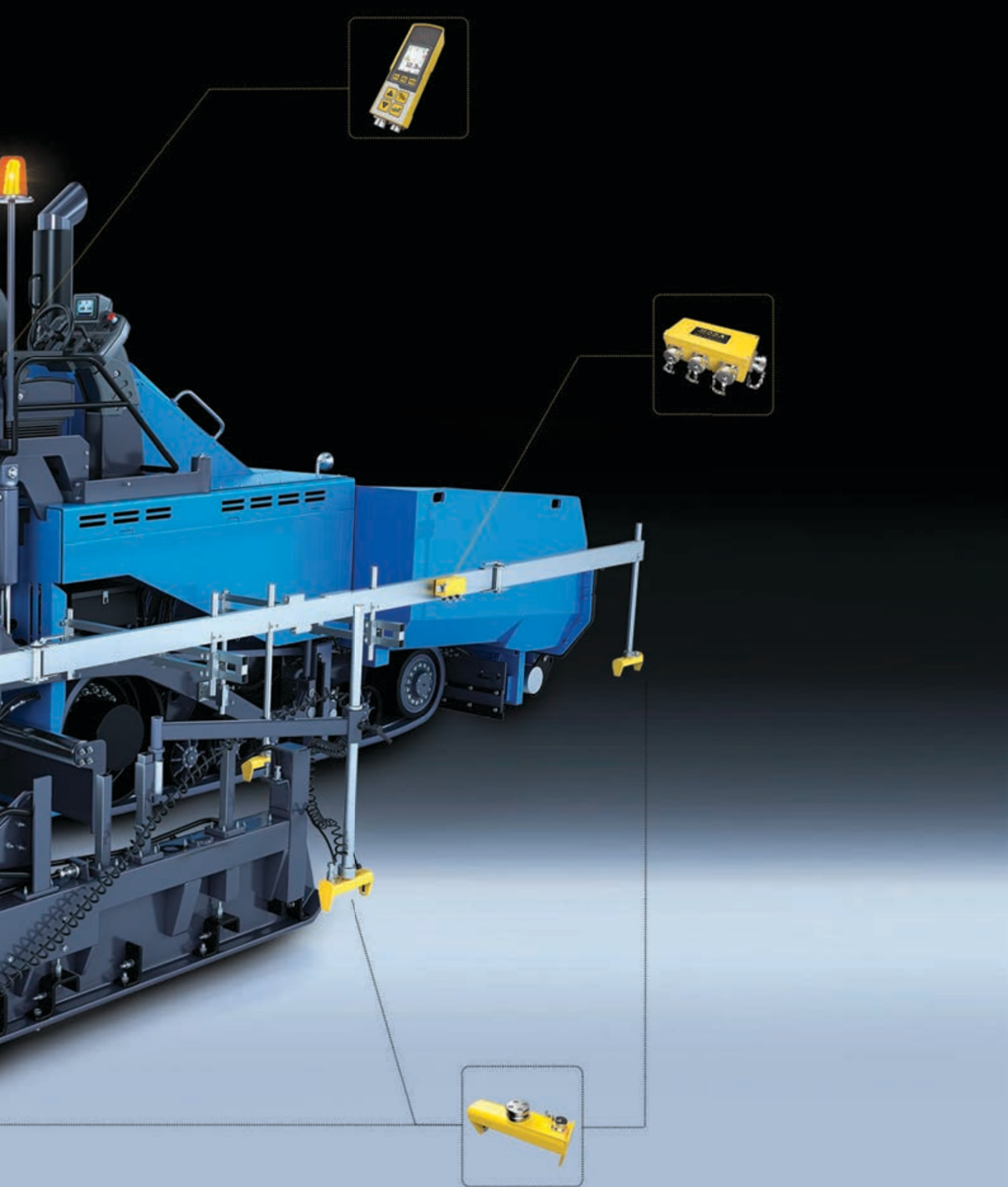













Thanks to years of development and market experience, MOBA-matic and Big Sonic-Ski are compatible with the pavers of any machine manufacturer – regardless of type or age. Thanks to the CAN-based development of further hardware components with a focus on the modularity of the system, additional features can easily be added.

1. **MOBA-matic II Controller** easy-to-use panel
2. **Big Sonic-Ski** unique sensor solution for height measurement
3. **Digital tilt sensor** for tilt indication during altitude control
4. **Laser Receiver LS-3000** linear detection of the laser beam
5. **Junction box** precise height position measurement for cutting applications
6. **IR-Spot temperature sensor** can be used at freely selectable positions of the paver



# MOBA-matic - OVERVIEW & FEATURES

## MOBA-matic - FUNCTIONS AND FEATURES OVERVIEW

					
FEATURES LIST		VÖGELE JUNCTION BOX	MOBA JUNCTION BOX FÜR VÖGELE	MOBA-MATIC I	MOBA-MATIC II
	Simple button operation	☑	☑	☑	☑
	Can be adapted to any hydraulic system	☑	☑	☑	☑
	Individual optimisation options	☑	☑	☑	☑
	Monochrome display	☑	☑	☑	☒
	Brillantes TFT color display	☒	☒	☒	☑
	Adjustable LED brightness	☒	☒	☒	☑
	Clearly illustrated information / Icon design	☒	☒	☒	☑
	Target / Actual Value Display	☒	☒	☒	☑
	Menu Buttons for additional Functions	☑	☑	☒	☑
	Additional display of a sensor value (e.g. temperature, slope, etc.)	☒	☒	☒	☑
	Multilingual Service Menu	☒	☒	☒	☑
	Can be remotely operated	☒	☒	☒	☑
	Path-dependent cross-slope control	☒	☒	☒	☑
	Ergonomic design	☒	☒	☑	☑
	Vögele Sonic-Ski Sensor (CAN)	☑	☑	☑	☑
	MOBA Sonic-Ski Sensor (CAN)	☒	☑	☑	☑
	MOBA Sonic-Ski PLUS Sensor (CAN / PWM)	☒	☑	☑	☑
	MOBA Sonic-Ski PLUS Sensor (CAN)	☒	☑	☑	☑
	Big Sonic-Ski with 3 Sensors	☑	☑	☑	☑
	Big Sonic-Ski with 4 Sensors	☒	☒	☒	☑

EQUIPPED FOR MIXED FLEET OF ASPHALT PAVING MACHINES

# THE EXPERT NETWORK - INSPIRING MOBILE AUTOMATION

Would you like to know how the system has already been successfully deployed by our customers? In the online expert blog, **MOBA Community**, you will find everything from job stories, feature releases, discussion forums to field reports to inform you in detail about our technologies.

Besides blog contributions regarding automation solutions of MOBA Mobile Automation AG, the Community offers numerous forums, discussions, event announcements or expert contributions about various topics of automation of construction machines. The **MOBA Community** acts as an interactive, international exchange platform for everybody who would like to participate actively in the development of this industry.

Contribute your own know-how and perspectives to interesting dialogues, post important questions regarding the (r)evolution of the industry and exchange opinions and experiences with other experts.

JOIN THE EXPERT NETWORK -  
**WWW.MOBACOMMUNITY.COM**



# ONE GROUP - ONE RESPONSIBILITY



📍 HEADQUARTERS    ● SUBSIDIARIES    ● DEALER

## MOBA GROUP

The **MOBA GROUP** is a leading global player in the world of mobile automation. Close collaborations between the headquarter in Limburg an der Lahn and subsidiaries all over Europe, Asia, North and South America create new perspectives for recent and future developments.

Superior technical know-how and more than 40 years of experience combined with an international dealer network guarantee a premium support - **worldwide. INSPIRING MOBILE AUTOMATION** - this is what the **MOBA GROUP** stands for since more than **40 years**.

### **MOBA GERMANY**

65555 Limburg / Germany  
Phone: +49 6431 9577-0  
E-mail: sales@moba.de

### **MOBA ITALY**

37069 Villafranca die Verona / Italy  
Phone: +39 045 630-0761  
E-mail: salesitaly@moba.de

### **MOBA FRANCE**

77164 Ferrières en Brie / France  
Phone: +33 (0) 1 64 26 61 90  
E-mail: infos@mobafrance.com

### **MOBA UK**

HP178LJ Haddanham / UK  
Phone: +44 184 429 3220  
E-mail: ilewis@moba.de

### **MOBA SPAIN**

08211 Barcelona / Spain  
Phone: +34 93 715 87 93  
E-mail: moba-ise@moba.de

### **MOBA USA**

Peachtree City GA 30269 / USA  
Phone: +1 678 8179646  
E-mail: mobacorp@moba.de

### **MOBA BRASIL**

Belo Horizonte - MG / Brasil  
Phone: +55 31 7513-4959  
E-mail: mobadobrasil@moba.de

### **NOVATRON FINLAND**

33960 Pirkkala / Finland  
Phone: +358 (0) 3 357 26 00  
E-mail: sales@novatron.fi

### **MOBA SWEDEN**

861 36 Timrå / Sweden  
Phone: +46 (0) 73-3750097  
E-mail: pwallgren@moba.de

### **MOBA TECMASERM**

08700 Barcelona / Spain  
Phone: +34 93 804 24 85  
E-mail: moba-tecmaserm@moba.de

### **MOBA CHINA**

116600 Dalian / China  
Phone: +86 411 39269311  
E-mail: ysun@moba.de

### **MOBA CHILE**

Avda. Providencia 1476  
Phone: +56 (9) 61678464  
E-mail: mjmarco@moba.de

### **MOBA INDIA**

Gujarat - 382044 / India  
Phone: +91 989 855 6608  
E-mail: sdesai@moba.de

### **MOBA DENMARK**

5250 Odense / Denmark  
Phone: +45 70 26 96 91  
E-mail: jlindskov@moba.de

### **MOBA AUSTRALIA**

Victoria 3061 / Australia  
Phone: +61 393 570 055  
E-mail: dramondetta@moba.de

www.moba-automation.com  
www.mobacommunity.com

**MOBA**<sup>®</sup>  
MOBILE AUTOMATION